

PRODUCT PORTFOLIO

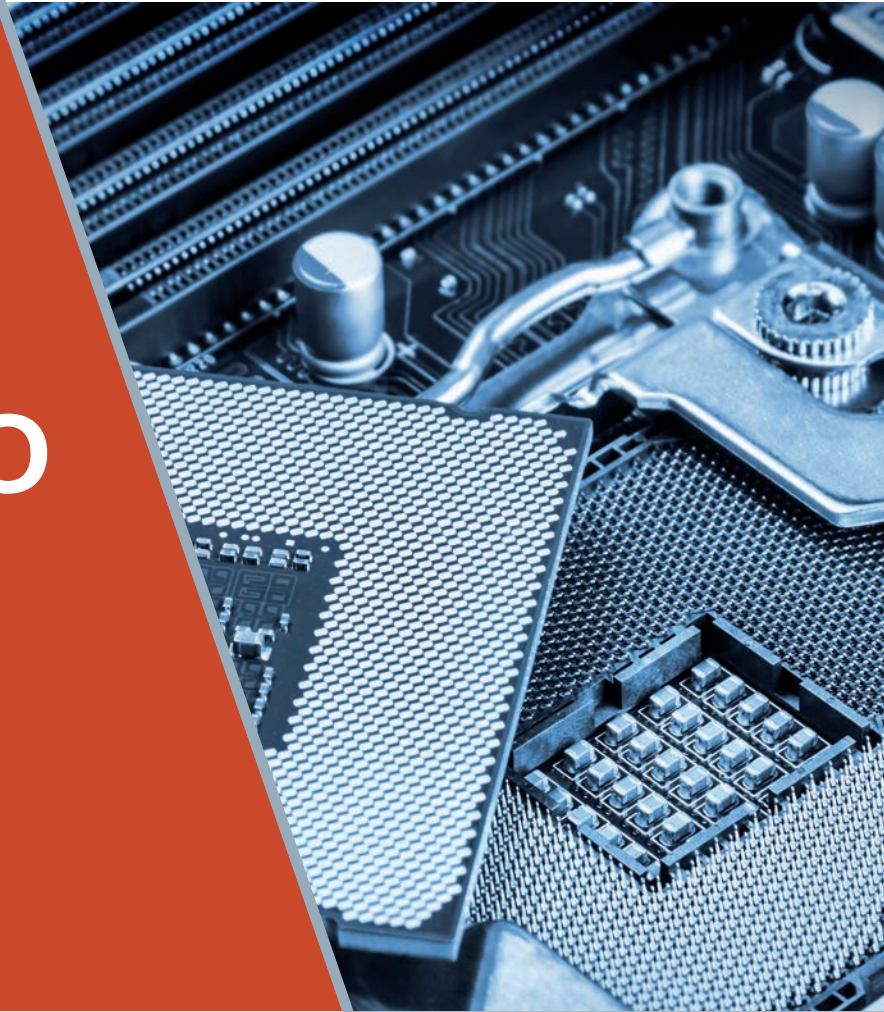

TEST / PRODUCTION SOCKETS & ADAPTERS

for BGA – LGA – QFN – QFP – SOIC – PLCC – LCC – PGA – Flat Pack and others



Fine pitch from 0.25mm pitch upwards (Standard & Custom)



Custom DevKit



Elastomeric technology
(low inductance)

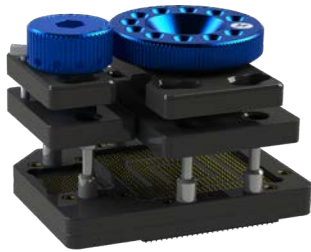

Full custom socket



Large test socket
up to 75x75mm

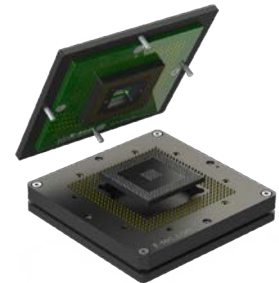

POP socket /
Dead bug socket



Burn in socket

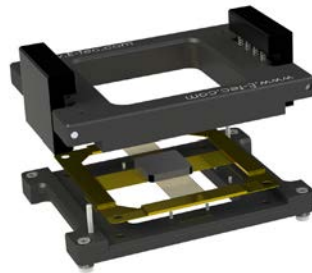

Open Top socket



FA socket



ATE socket



Socket for end customer PCB
(Test socket for PCB not intended to accept socket)



High frequency
up to 110 GHz

IC-SOCKETS & INTERCONNECT PRODUCTS

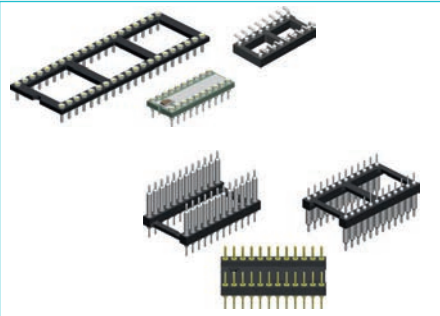

DIL-Sockets/Spacer/Adapter
(THT - SMT - LowProfile - Capacitors)

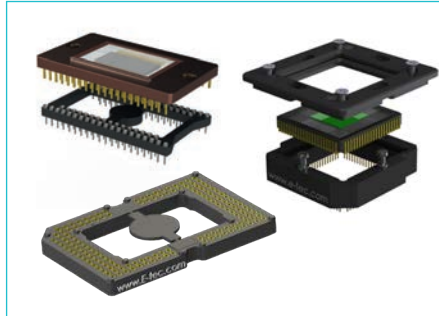
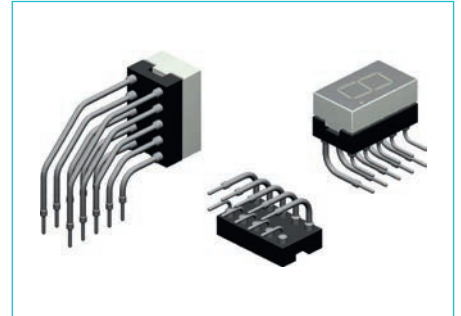
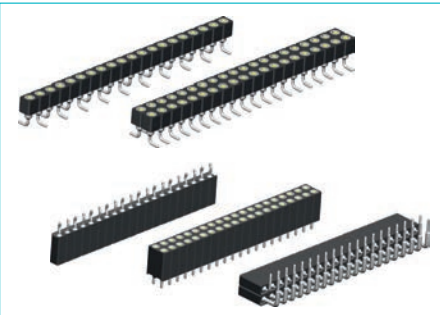

Image Sensor Socket
(Standard & Custom)



Precision Sockets
for 7-Segment LED Display



SMT / THT Socket Strips

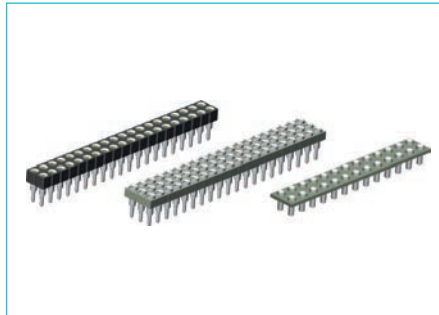

Low Profile Socket Strips

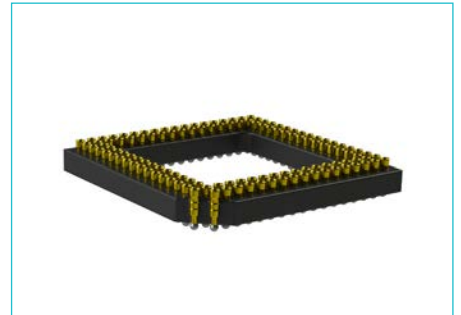

Solderball MiniGrid Socket

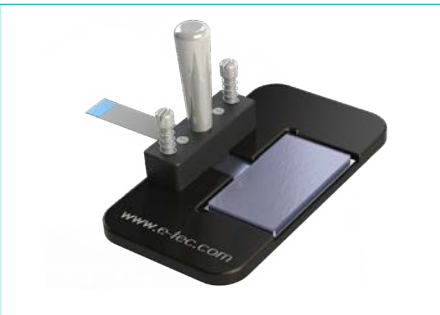

Flat Flex Cable, Display &
Test Unit

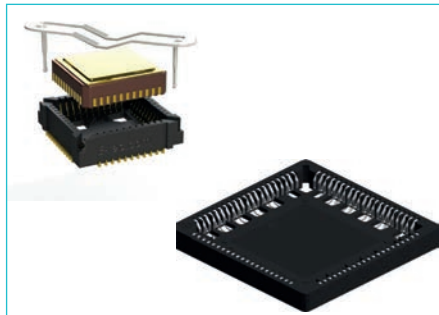

LCC / PLCC Sockets

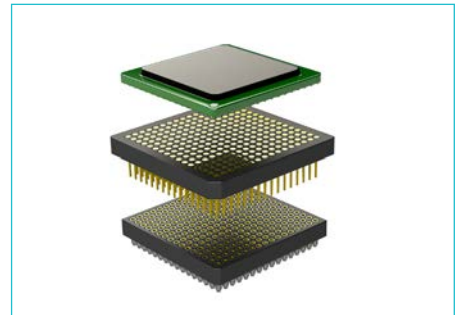

BGA Adapter THT & SMT

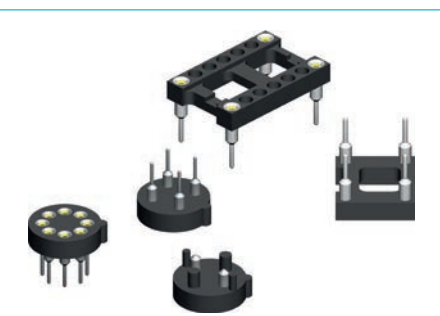

Crystal Oscillator-, Transistor-,
TO-Sockets and Fuse Holders



Contact Terminals &
Screw Machine Parts

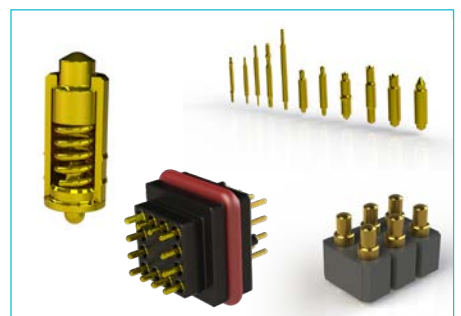

Probe-Pins & Connectors
Standard and Custom

PCB INTERCONNECT PRODUCTS

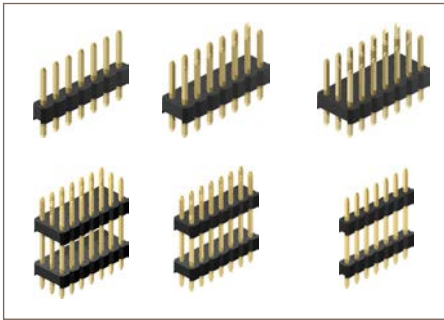

THT Pin Header
Board Spacer straight

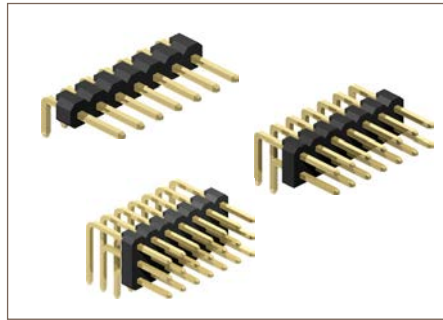

THT Pin Header right angle

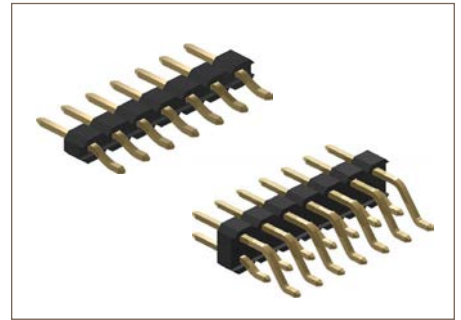

SMT Pin Header horizontal

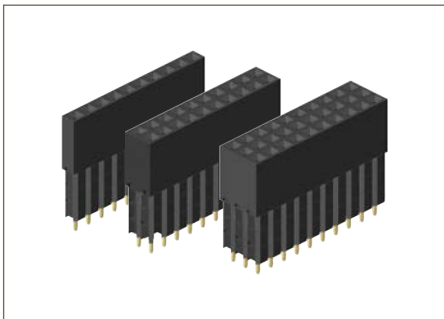

THT raised Female Header

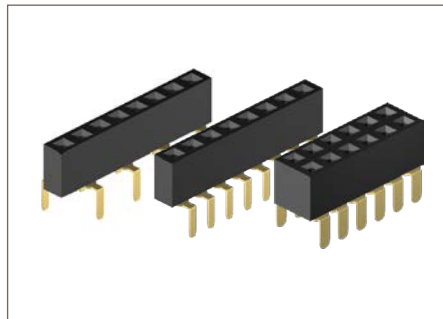

THT dual entry Female Header

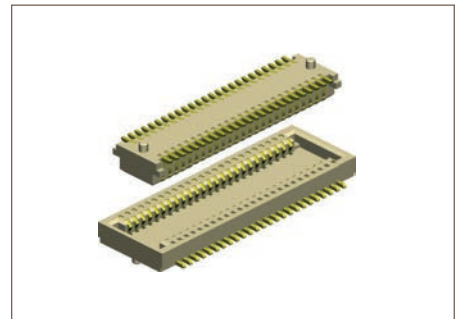

Fine Pitch Low Profile
Connectors

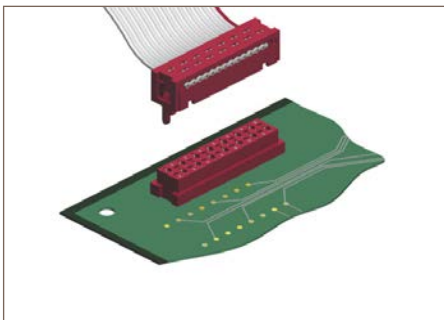

Mini Flex Connector System

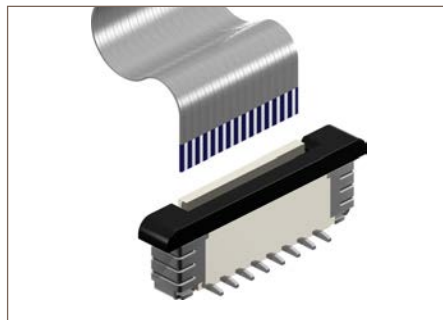

Flex Cable Connectors

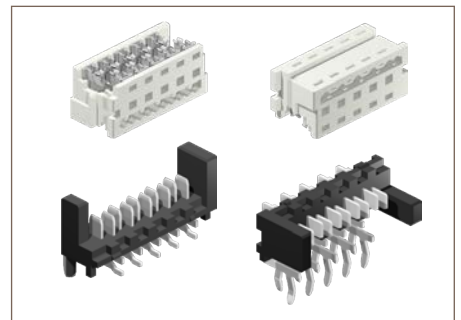

PicoMate Connectors

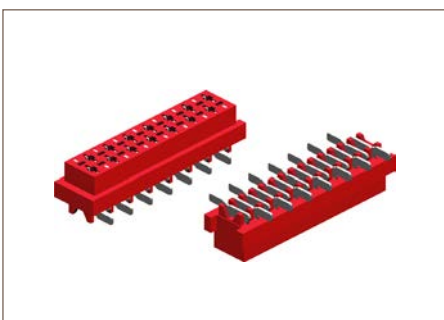

Mini Mate Connector System

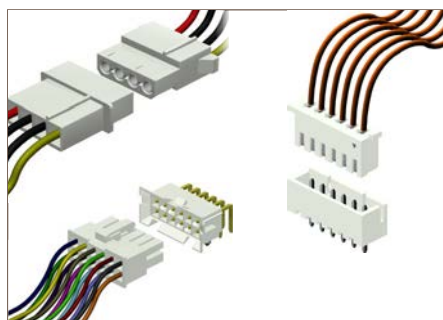

Wire to Board Connectors



LED Connectors

PCB INTERCONNECT PRODUCTS

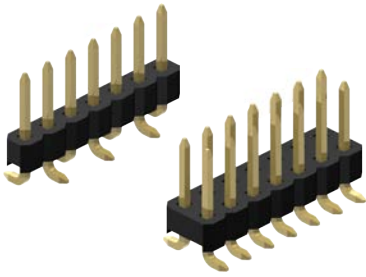

SMT Pin Header vertical

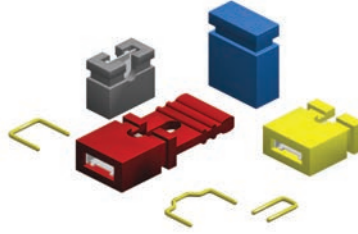

Jumper & Shorting Links

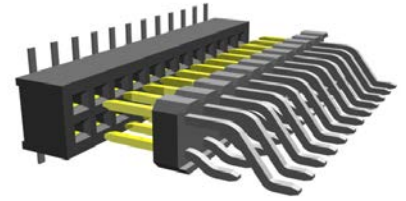

SMT male & female Header
B-t-B combination

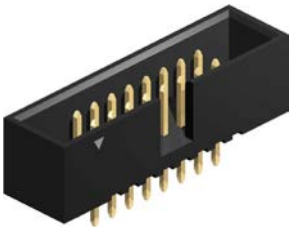

Box Header

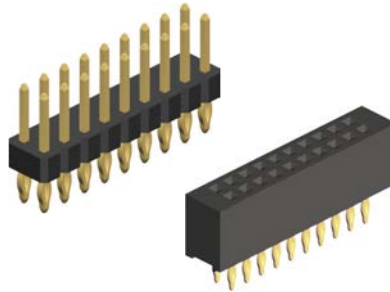

Press Fit Header

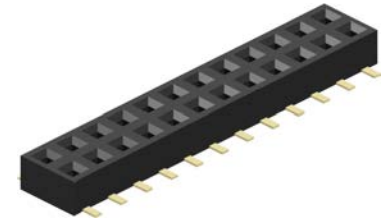

SMT Female Header

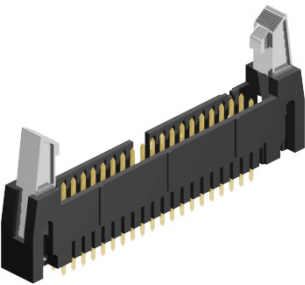

DIN Header

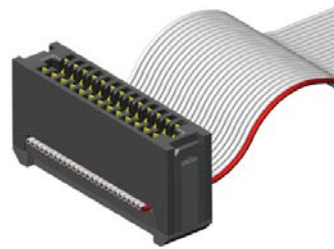

IDC Connectors

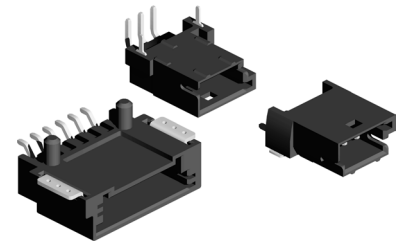

Customized Connectors
for Automotive Use



Qseven / MXM Connectors
M.2 Mini PCI Express



PCI Express & Card Edge Connectors
DIMM & SO-DIMM Sockets
DDR (1 - 4)

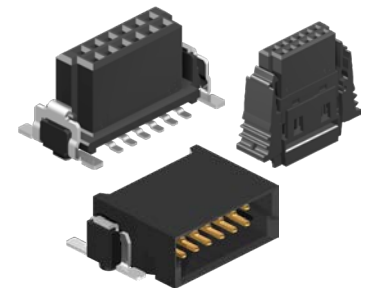

MultiBackplane Connectors

D-SUB & I/O CONNECTORS

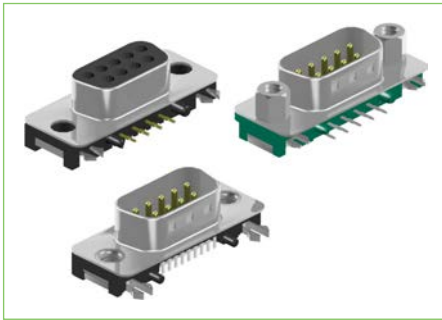

Ultra Slim Profile



Vertical Type

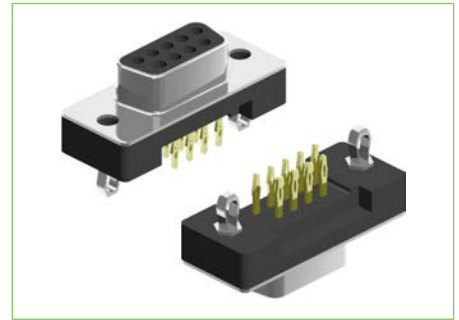

Press Fit Type



Solder Cup & Solder Tail

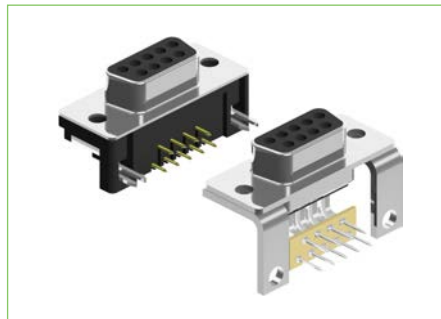

Horizontal „US“ & „Euro“
Type



with Filter

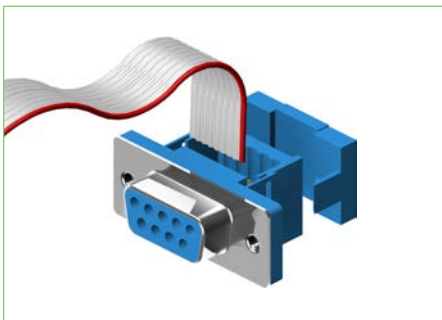

IDC-Type

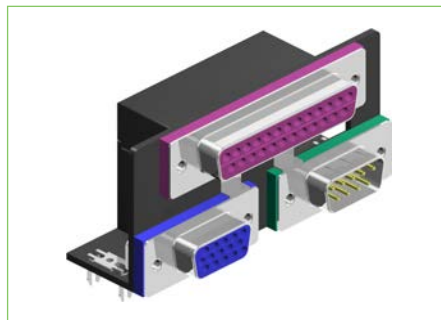

Multi Port



Waterproof

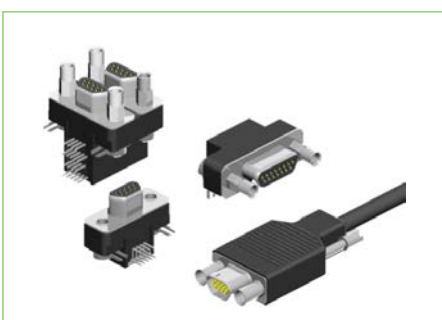

Micro D-Sub

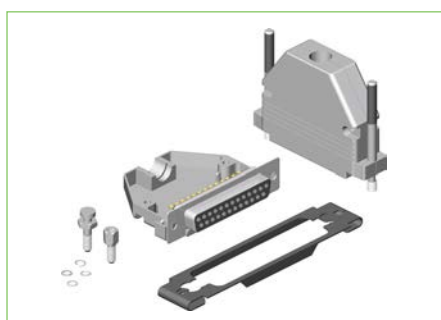

D-Sub Hoods & Accessories



DVI Connectors

I/O CONNECTORS

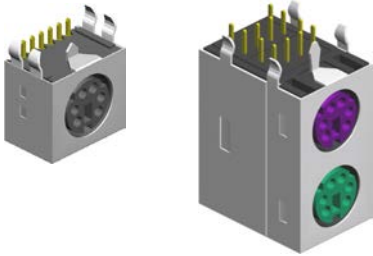

Mini DIN Connectors



Mini DIN wall mounting
Mini DIN Plugs

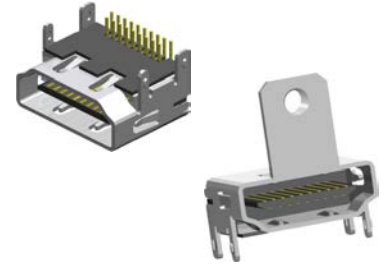

HDMI Connectors

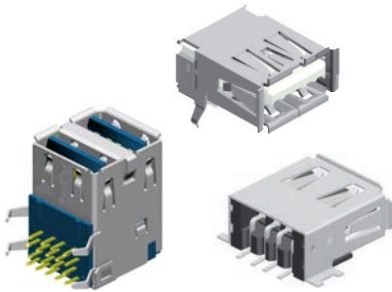

USB Connectors Type A
1.x / 2.0 / 3.0



USB Connectors Type C

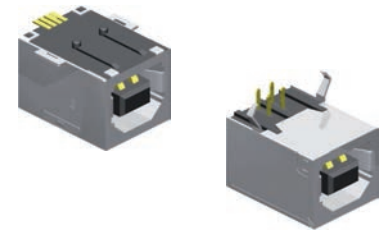

USB Connectors Type B

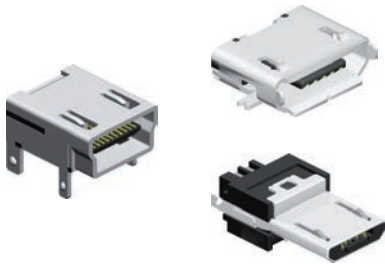

Mini & Micro
USB Connectors



USB Cable Assembly

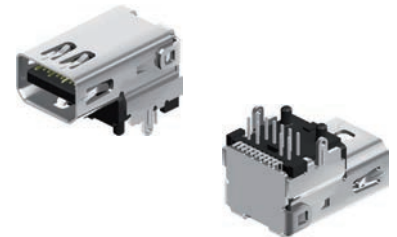

Mini Display Port Connectors



M8 / M12 Connectors
(Panel Mount / Cable Assembly)

SWITCHES

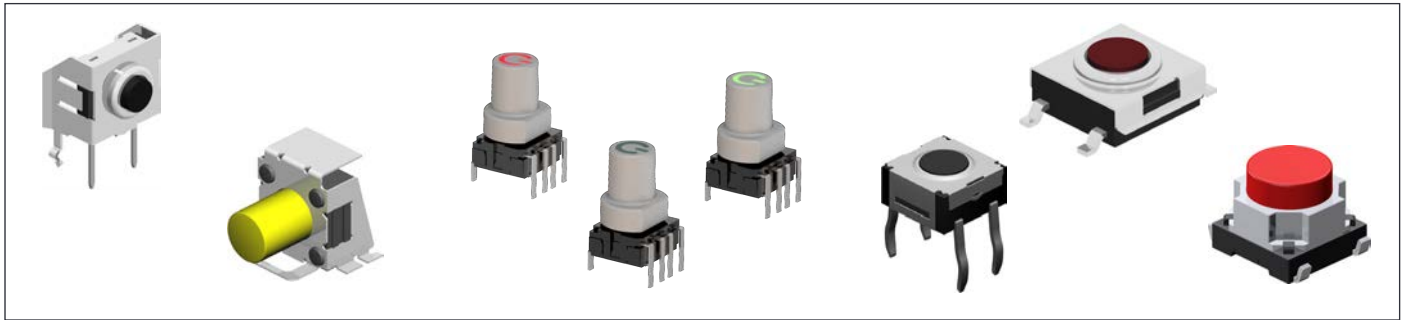

Tact Switches

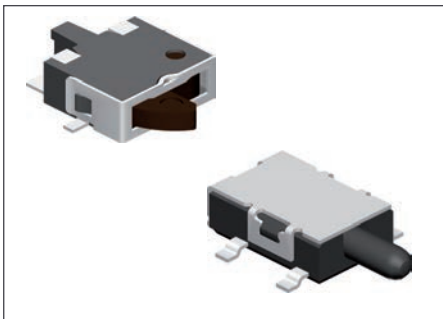

Detector Switches

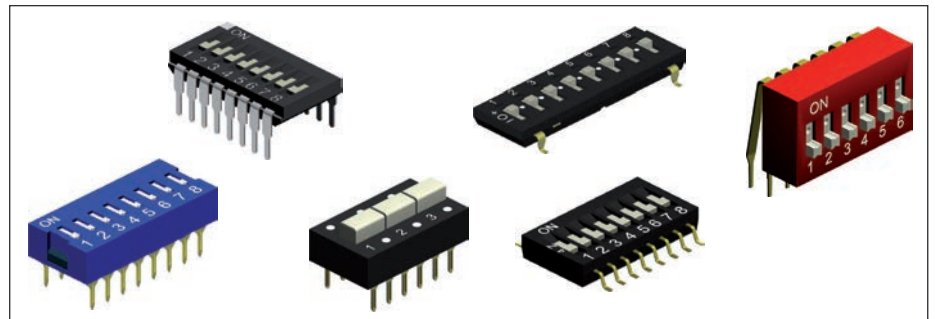

THT & SMT - Right Angle DIP Switches

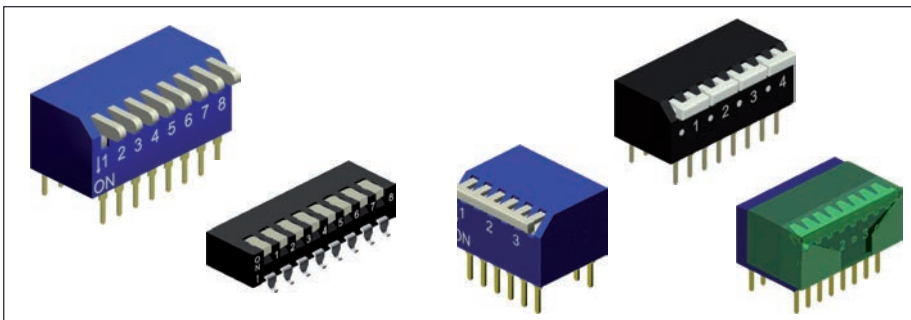

THT & SMT Piano Switches

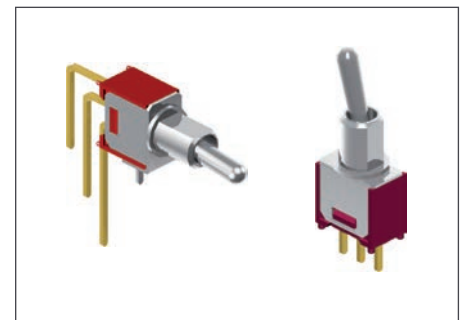

Toggle Switches

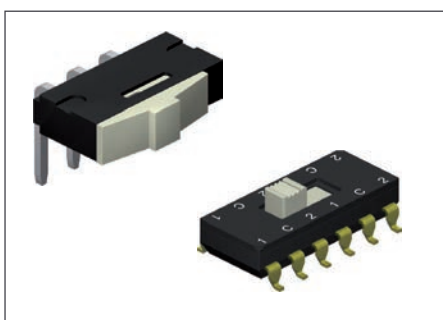

Change-over & Selector
Slide Switches

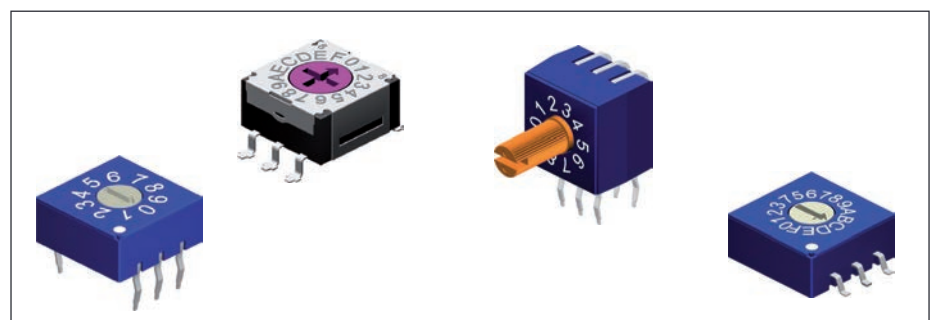

THT & SMT - Rotary Switches

MODULAR JACKS & PLUGS

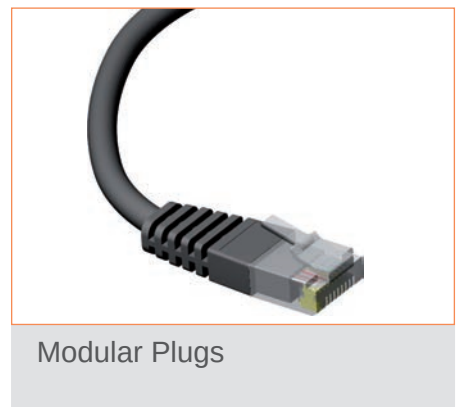
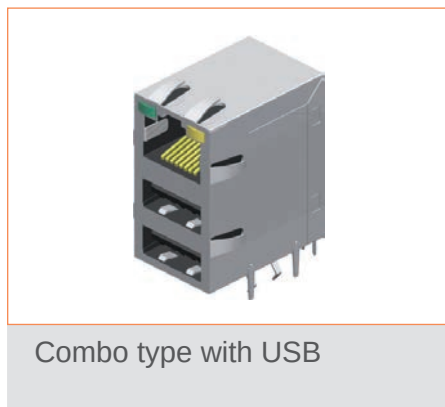
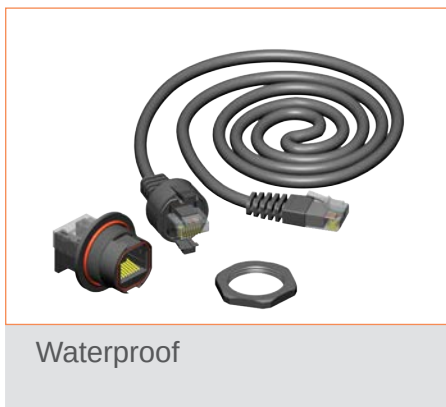
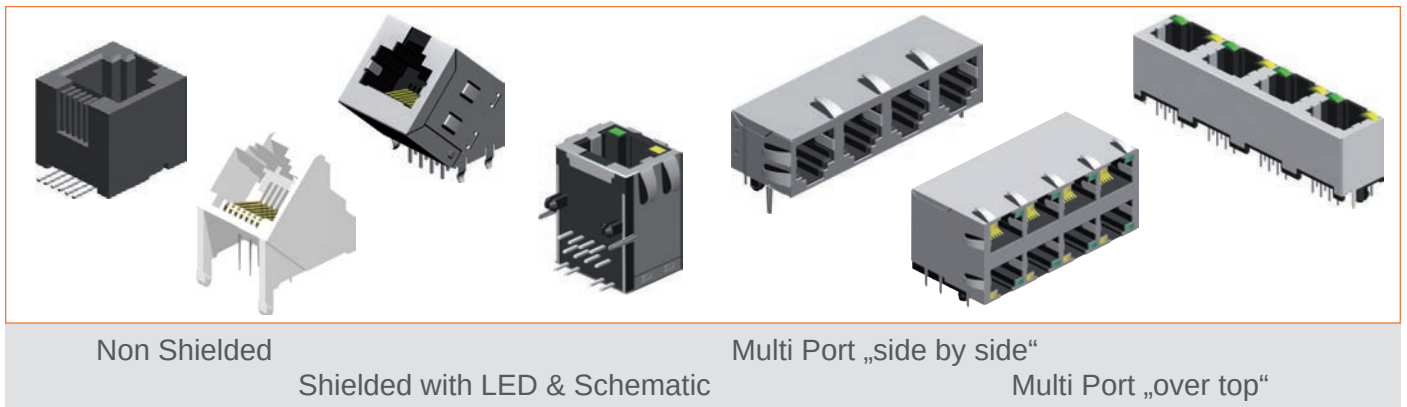

EARPHONE & DC POWER CONNECTORS

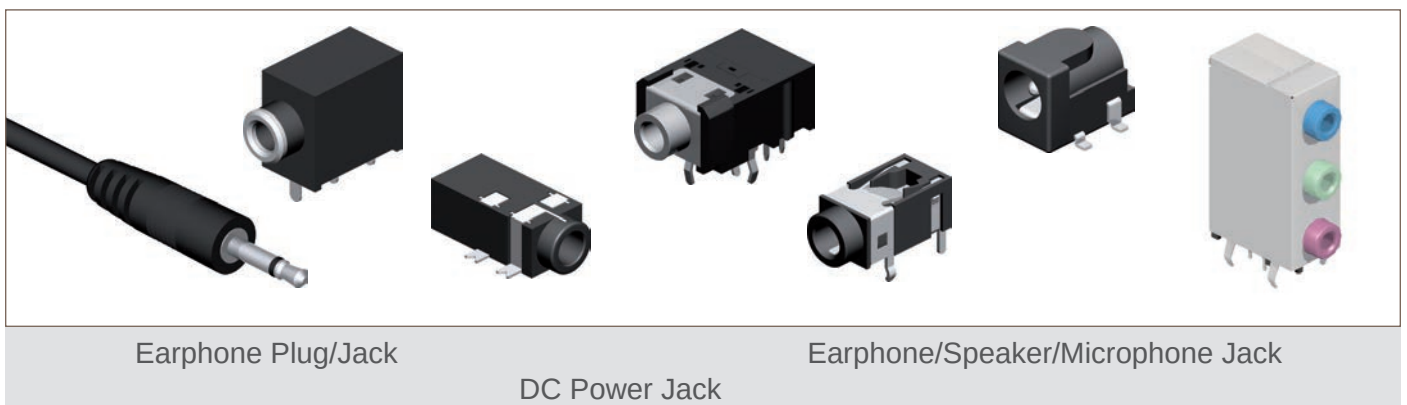

TERMINAL BLOCKS (EURO STYLE)

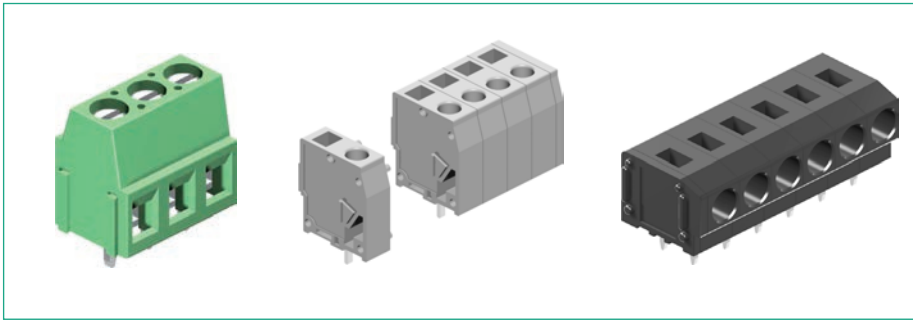

THT Clamp

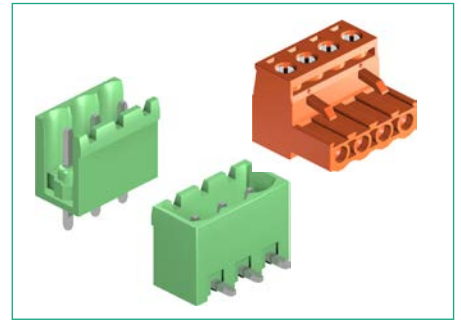

Plugs & Receptacle

CABLE ASSEMBLY

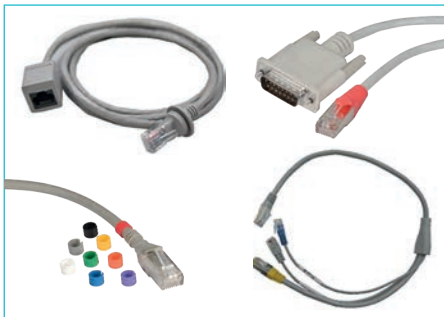

LAN Cable



Power & Small Signal Cable



LVDS, IDC & Crimp Cable



Customized Cable Assembly

RF / COAXIAL CONNECTORS



SMA / SMA Reverse / SMB Types



MCX / MMCX Types



1.6/5.6 Types

WIRE TO WIRE CONNECTORS

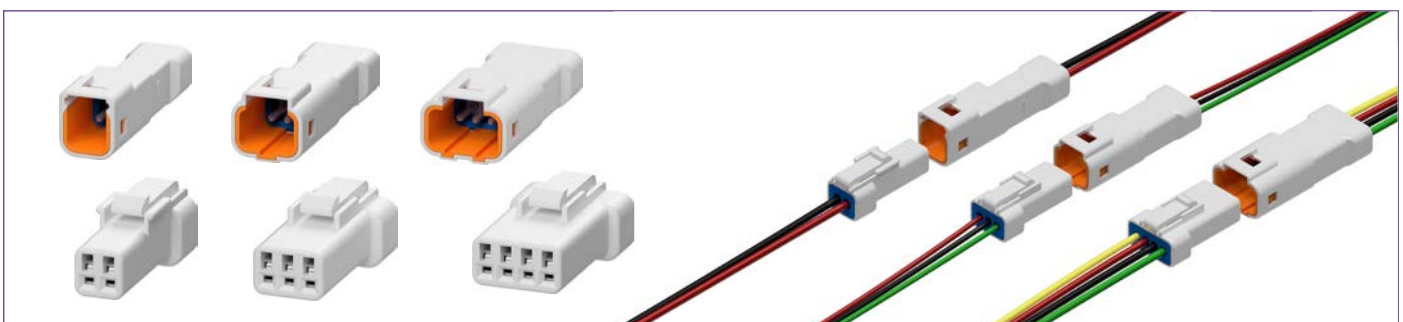

Waterproof Wire to Wire Connectors

The E-tec Group

For over 40 years E-tec have manufactured and supplied a diverse range of electronic interconnect solutions across the global market. Our portfolio has grown with our customers, to include Test Sockets, IC sockets, PCB interconnect products, D-Subs, Switches, RF connectors and cable assemblies. We design, develop, produce and provide sales and support directly to our customers. With production facilities in Switzerland, Taiwan, UK and China, we offer flexible capacity with short delivery times from prototype to large volume production series. In this way, E-tec are ideally positioned to provide a genuinely global service, from product conception to production, wherever and whenever our customers require it.

E-tec connectors, cables, sockets and specials are found in the most demanding of application fields, including; aerospace, automotive, communications, defence, medical, pumping and vacuum, sensor and safety equipment, transportation and much more. At E-tec, our experienced team understand uncompromising quality and dedicated service are the foundations of successful project delivery. We are ISO9001 certified, and many products are UL listed and TS16949 accredited to meet exacting industry standards. We welcome your enquiries, please contact us or visit our website and we will respond promptly.



International Sales Office & Factory

E-tec Interconnect AG

Friedhofstrasse 1
CH-2543 Lengnau b. Biel
Switzerland

Phone: +41 (0) 32 654 15 50
Fax: +41 (0) 32 652 26 93
Email: info@e-tec.com
Web: www.e-tec.com



Taiwan Sales Office & Factory

E-tec Interconnect Asia Ltd

7F, No. 69, Sec 2, Guangfu Rd.
Sanchong Dist., New Taipei City
24158 Taiwan R.O.C.

Phone: +886 / 2 / 2999-2726
Fax: +886 / 2 / 2999-5255
Email: info@e-tec-asia.com.tw
Web: www.e-tec.asia



Germany Sales Office

EMC
electro mechanical components GmbH

Deningerstrasse 4a
D-65510 Idstein

Phone: +49 (0) 6126 / 9 395-0
Fax: +49 (0) 6126 / 9 395-72
Email: info@emc.de
Web: www.emc.de



United Kingdom Sales Office

E-tec Interconnect UK Ltd
Units 5-7 Decimus Park

Kingstanding Way
Tunbridge Wells
Kent TN2 3GP

Phone: +44 (0) 1892 / 530 260
Fax: +44 (0) 1892 / 515 560
Email: info@e-tec.co.uk
Web: www.e-tec.co.uk



France Sales Office

STELIAU Technology

41-43 rue Périer
92120 Montrouge

Phone: +33 (0) 1 / 55 58 04 04
Fax: +33 (0) 1 / 55 58 04 00
Email: contact@steliau-technology.com
Web: www.steliau-technology.com

Your Distributor / Representative